

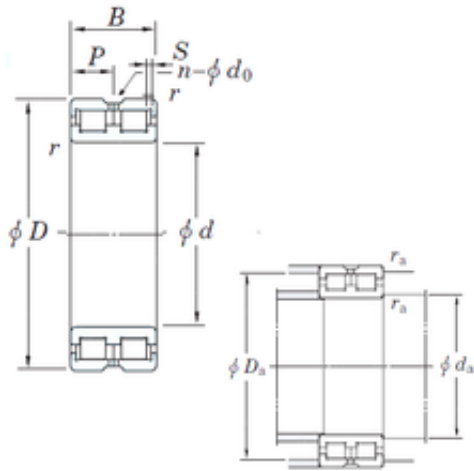

NTN BEARINGS INDUSTRY



DC4844VW KOYO Full complement cylindrical roller bearings

Bearing No. DC4844VW

DC4844VW Bearing 2D drawings and 3D CAD models

Size	220x270x50 mm
Bore Diameter	220 mm
Outer Diameter	270 mm
Width	50 mm
d	220 mm
D	270 mm
B	50 mm
C	50 mm
n	6 mm
p	25 mm
r min.	1,5 mm
S	4 mm
da min.	228,5 mm
Da max.	261,5 mm
ra max.	1,5 mm
Weight	6,4 Kg
Basic dynamic load rating (C)	355 kN
Bearing No.	DC4844VW
r(min)	1.5
Cr	355
C0r	971
S	4 mm
P	25
n(qty)	6
do	4



NTN BEARINGS INDUSTRY

da(min)	228.5
Da(max)	261.5
ra(max)	1.5
(Refer.)Mass(Fixed side)(kg)	6.20